

# DROP

Professional Series



## Installation Manual & User Guide Single Tank Aeration Filter

Available on the  
App Store

ANDROID APP ON  
Google play

Home Assistant

amazon alexa

 CHANDLER SYSTEMS

# INTRODUCTION

## Thank You for Purchasing a DROP System!

We know you'll love your improved water quality, leak detection ability and water conservation benefits of your new DROP Water Management System from Chandler Systems. You'll soon wonder how you ever lived without it. Improving your water and protecting your home are just a few of the ways that the DROP Water Management System can improve your water system.

Be sure to check out the [dropconnect.com](http://dropconnect.com) website periodically for more information about additional DROP products as they are released.



833.BUY.DROP  
(833.289.3767)



drop.pro

To further help you operate your new DROP system, we have provided you with many other resources for you to learn more. Feel free to call Chandler Systems when you need additional help. We also have many resources located on our website including instructional videos, and images.

DROP Connect is also active on various social media pages! Feel free to follow us for the most up to date information and news!



@dropconnect



### Privacy Statement

For more information about privacy, visit our [privacy policy](http://dropconnect.com/sites/default/files/DROP-Privacy-Statement.pdf) online.  
([https://dropconnect.com/sites/default/files/DROP-Privacy-Statement.pdf](http://dropconnect.com/sites/default/files/DROP-Privacy-Statement.pdf)) online.

### DROP Patents

For the most up-to-date list of patents, visit our patents on our website: <https://dropconnect.com/patents>.

### FCC Compliance Statement:

[https://dropconnect.com/sites/default/files/FCC\\_Compliance\\_Statement.pdf](https://dropconnect.com/sites/default/files/FCC_Compliance_Statement.pdf)

### Industry Canada Compliance Statement:

[https://dropconnect.com/sites/default/files/Industry\\_Canada\\_Compliance\\_Statement.pdf](https://dropconnect.com/sites/default/files/Industry_Canada_Compliance_Statement.pdf)



# TABLE OF CONTENTS

Introduction.....	2
Table of Contents.....	3
How to Use Your System.....	4
Installation Instructions.....	6
Common Questions.....	13
How It Works.....	15
Download the App.....	16
Before You Begin.....	17
Guided Setup .....	19
App / Hub Pairing.....	20
Adding & Naming Devices.....	22
Network Troubleshooting.....	24
Alexa & Home Assistant.....	25
Operations.....	26
Leak Detectors.....	35
DROP Remote.....	38
DROP Warranty.....	41

## CAUTION:

- Do not subject tank to any vacuum. If there is a possibility that a vacuum could occur, a vacuum breaker must be installed.
- Do not locate unit where the tank or any lines (including drain lines) will be subject to temperatures below freezing.
- If there is not at least 10' of line between the water heater inlet and the outlet of the closest softener/filter, an expansion tank should be installed.
- Do not use Vaseline or any petroleum-based lubricants on O-rings or rubber seals. Only use food-grade silicone lubricant.
- O-rings are lubricated before leaving the factory and do not require additional lubrication before installation in most cases.
- Do not use pipe dope or any sealant other than Teflon tape on threaded connections. Threads on the control valve and on the bypass nut connections do not require any tape because they use an O-ring seal. Tape is only required on the inlet/outlet adapter fittings and on the drain line fitting (if applicable).

# HOW TO USE YOUR SYSTEM

Your DROP Water Management System was selected to address your specific water conditions. Your system uses advanced technology to deliver effective and efficient water treatment to protect your home plumbing system, deliver optimal water quality to you and your family, protect your home from leaks, and save you money, all while providing years of trouble-free operation.

## Your system operates in two primary modes:

**In Service:** Your water is filtered as it passes through the filter media in your tank.

**Regeneration:** Your system cleans itself by backwashing the media to remove the filtered contaminants, and to reorient the media. It will then rinse to ensure the system is clean before returning to In Service Mode.

Note: Water to your home is not treated while in regeneration.

## Additional Features You'll Find on Your DROP System

- **Advanced Electronic Control Valve:** Incorporates the latest filter control technology for optimal performance, efficiency and longevity.
- **Optical Sensor Technology:** Optical sensors control regeneration for precise performance.
- **High Flow Media Tank:** Your DROP system delivers the high flow rates required by today's demanding households.
- **Integrated By-pass Valve:** Allows you to take your system out of service if necessary.
- **Power Backup:** To continue to protect your home during power outage
- **Water Usage Monitoring** - DROP monitors your water usage and provides real time information including: current water flow, peak flow today, daily average of the last 30 days, as well as many useful historical charts.
- **Automatically integrates with other components on your DROP System** - DROP is a water management system that integrates all of the water related devices in your home including: water softeners, backwashing filters, leak detectors, sump pump alarms, and many more to come!
- **Convenient User Interface on your Smart Phone or Tablet**
- **LED Light Codes:** Alert you to system status at a glance.
- **Regeneration Status:** During a regeneration, the App will show the cycle and the time remaining in that cycle.
- **Regeneration Cycle Override:** During regeneration, you can force the system to move to another cycle step immediately by selecting a different cycle step in the App.





# HOW TO USE YOUR SYSTEM

**Manually Bypassing Your System:** DROP's integrated bypass valve allows you to bypass your system should you ever wish to take it offline. To bypass your system, turn both handles until they are perpendicular to the system inlet / outlet. To place your system back online, turn both handles until they are parallel with the system inlet / outlet.

## SERVICE

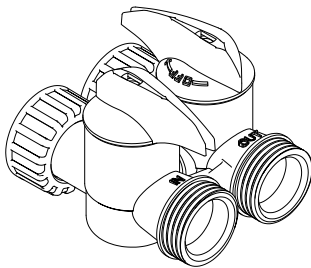

**System In Service - Water to home is being treated**

## OFF

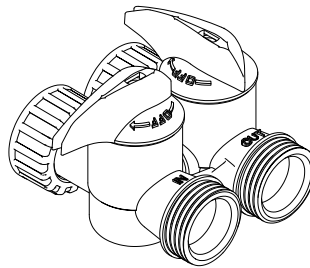

**Water to home and filter is off**

## BYPASS

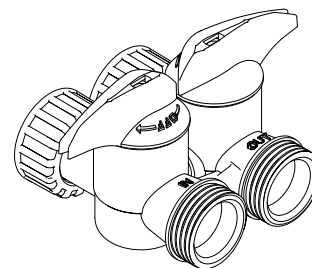

**System Out of Service - Water to home is on and untreated**

# INSTALLATION INSTRUCTIONS

## Contents of Carton

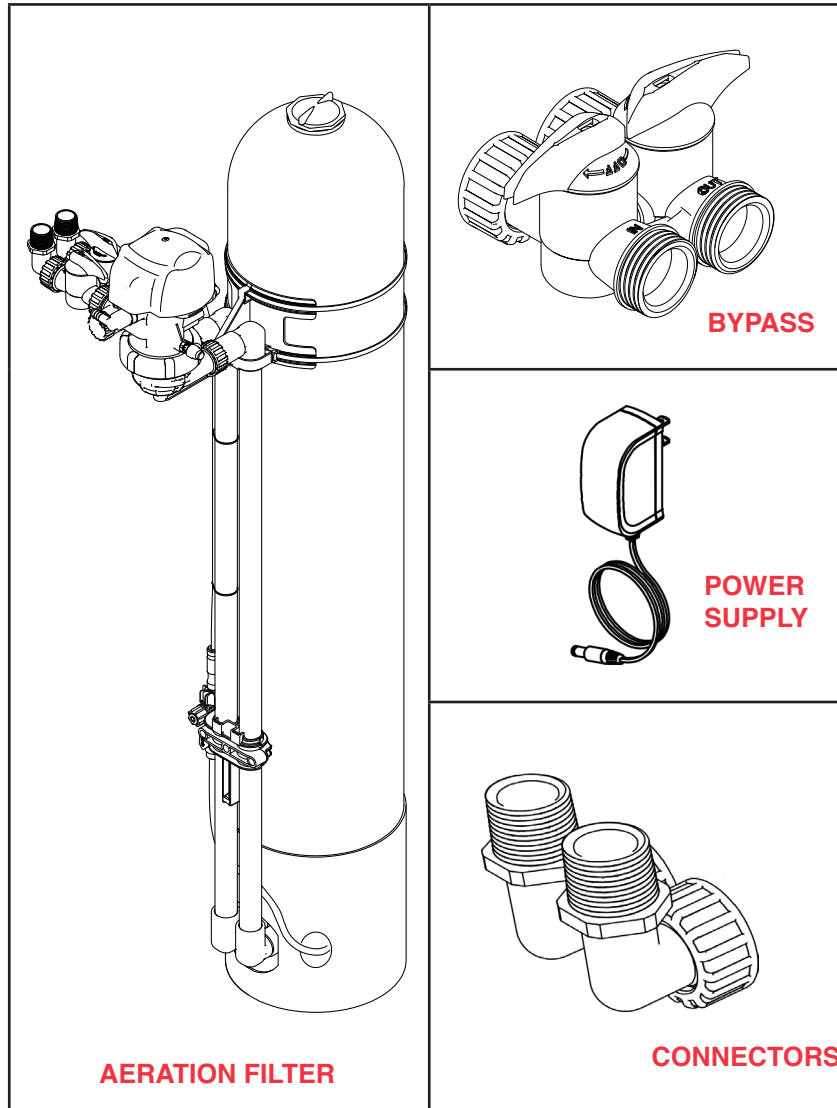

# INSTALLATION INSTRUCTIONS



## Precautions



**Read Installation Manual**

**If existing plumbing is copper, install grounding strap before creating plumbing gaps.**

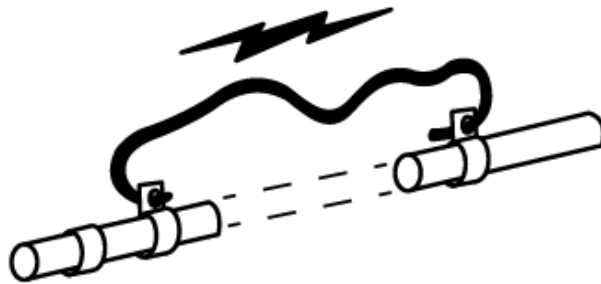

# INSTALLATION INSTRUCTIONS

## System Setup

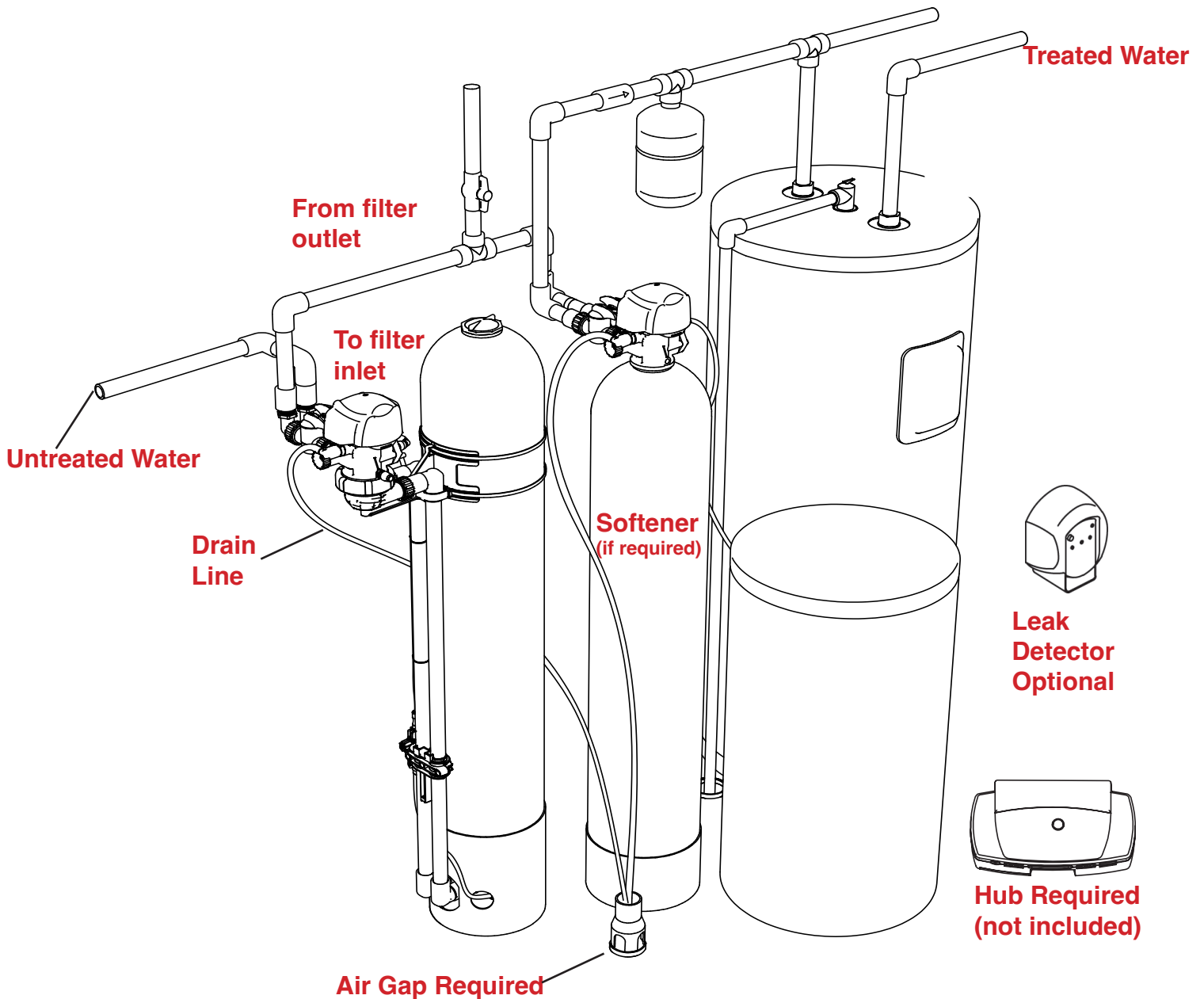

\*

Note: Your installation may vary. Follow all local plumbing codes.

\*If there is not at least 10' of line between the water heater inlet and softener outlet, a thermal tank expansion tank should be installed at water heater inlet.



# INSTALLATION INSTRUCTIONS

## System Setup

Unpack equipment and unscrew the black cap from the filter tank by turning counter-clockwise. Position the tank in the area where it is to be installed. This should be a hard level surface with access to plumbing, drain, and an electrical outlet. Use a garden hose or a bucket to fill the tank 1/3 full of water. Then add filter media to the tank. Be sure to plug the center distributor tube so that no media enters the tube. (Media funnel and distribution tube plug provided)

Note: 10x54" tanks require 1.5 cubic feet of filter media; 13x54" tanks require 2.5 cubic feet of media.

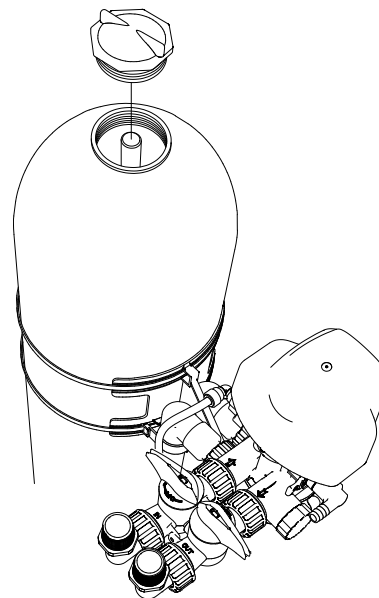

After media is added, remove the plug from the distributor tube, and fill the tank the rest of the way (up to the bottom of the tank threads) with water. This will allow the filter media to soak while the installation process is completed. Make sure that tank threads are clean and free of any media fines, and screw the control valve back onto the tank.

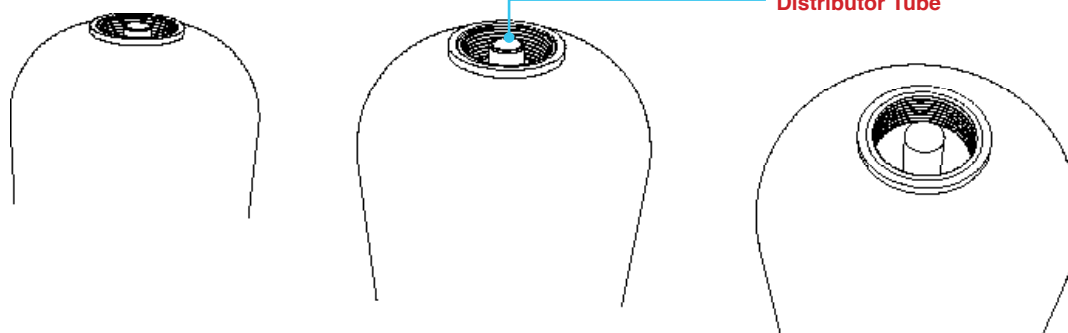

# INSTALLATION INSTRUCTIONS

## System Setup

Connect bypass valve and connectors to the control valve. Attach components by pushing the adapters together and tightening the nuts by hand until they feel snug.

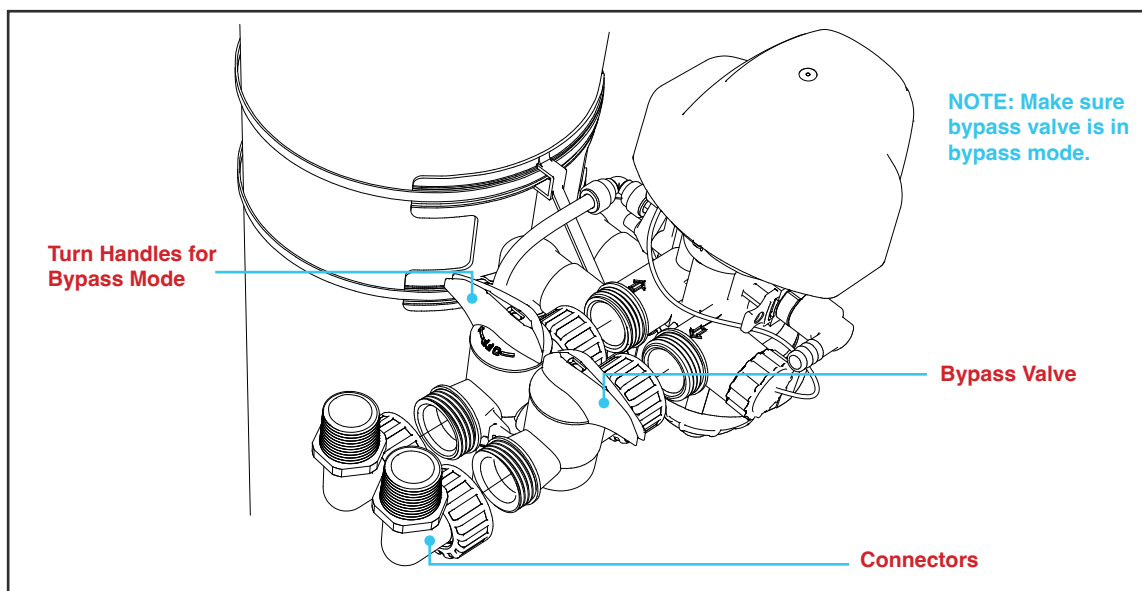

Turn off main water supply and open nearest cold faucet to relieve pressure. Cut water supply line, and connect plumbing to the inlet and outlet accordingly.  
**Note:** Inlet and outlet connections are 1" NPT. Additional piping and / or fittings

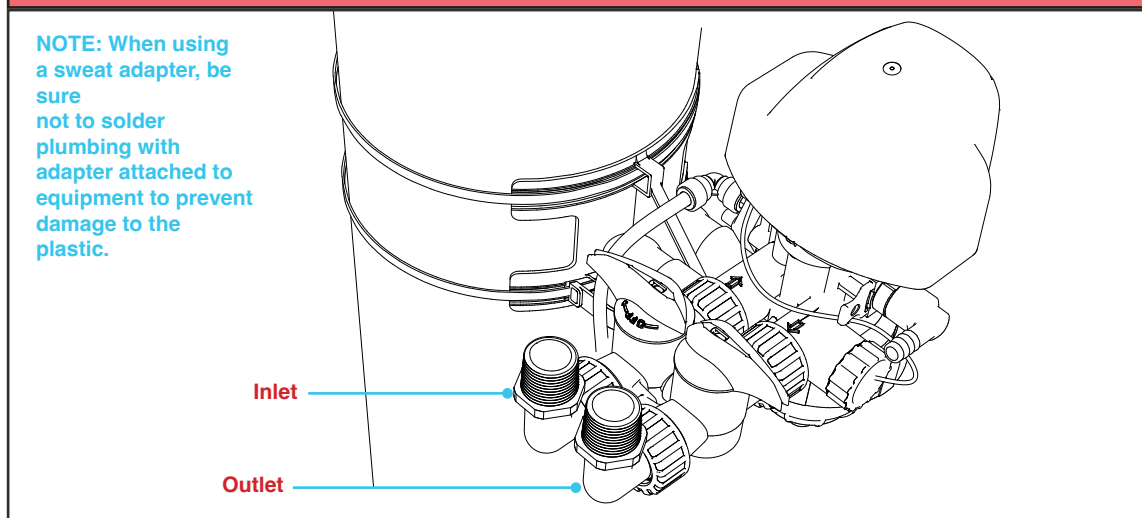



# INSTALLATION INSTRUCTIONS

## System Setup

Connect drain line to barbed drain adapter and run to appropriate discharge point. Use a 1/2" minimum pipe size for the drain. Use a 3/4" drain line for runs that exceed 20 feet. Make connection to a sanitary waste system through an air gap of 2 pipe diameters or 1", larger. Do not tee into any other drain lines.

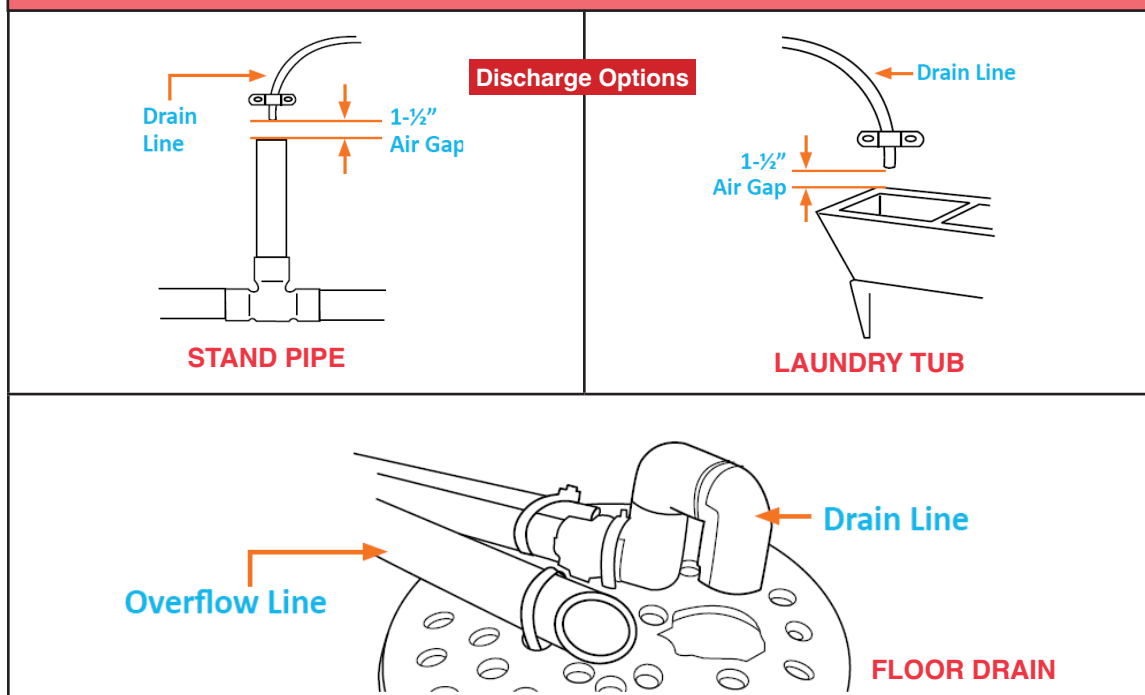

With the bypass valve still in bypass position, turn on the main water supply. Open a cold, treated water tap nearby and let run a few minutes or until the plumbing is free from foreign material (usually solder) that may have resulted from the installation. Once clean, close the water tap, open the bypass valve, and re-open the tap. Allow water to run until it is clear and free of media fines.

# INSTALLATION INSTRUCTIONS

## System Setup

**Place the DROP Hub in a central location in your home and plug it in.** At this point, you can download the DROP Connect App on your device. When you open the app, it will walk you through the process of connecting to your Hub and connecting to WiFi, if desired.

### Adding devices to the DROP system

Once you have connected to the Hub, you can use the app to connect your devices (softener, leak detectors, salt sensor, etc) to the Hub. First, unplug and remove any batteries from the DROP device you wish to add. Next, navigate to the 'System' (selection on left) > 'Advanced' (selection at top) page in the app and enable the 'Add Device Components' mode. The hub will enter a state where it will accept new connections. Plug in the device(s) that you are adding, or for a leak detector, simply install the batteries. After the device has joined the DROP network you will see it added to the "Manage Device Components" table, you can then disable the 'Add Device Components' mode or simply wait for it to automatically disable.

When a new device is added to the system, you can rename that device by choosing "System" on the left navigation menu and scrolling to the bottom of the System Status page. Devices such as the softener and salt sensor will already be labeled appropriately, but in the case of leak detectors, each individual leak detector will simply be labeled "leak detector." In this case, you can rename each leak detector according to where you put them, such as "water heater" or "kitchen sink."

### System Settings

The first settings that should be reviewed are the Regeneration Time and System Water Source. Choose "System" on the left navigation menu and it will bring you to the System Status page, where these settings can be adjusted if needed.

#### Regeneration Time

This setting controls the time of day when the system will begin to regenerate. While a softener or filter is in its regeneration cycle, any water used in the house will not be treated. Therefore, it is important to choose a time of day where water use is least likely. It is also important to understand how long the regeneration of your system will take. For a filter with standard settings it will take approximately 30 minutes. Some DROP installations will require multiple filters and/or softeners. These stages can require regeneration on the same day and would occur one after the other starting at the regeneration time, so you should select a regeneration start time that would take these times into consideration along with your water usage schedule.

#### System Water Source

The system water source setting is used by the DROP system to know how to respond to power outages. It can be set to Private Well or Municipal Supply. If your water supply is not one of these choices, if your water supply is dependent on power to be available (i.e. it is supplied by an electric pump) set it to Private Well, otherwise set it to Municipal Supply.



# COMMON QUESTIONS

**Extra Cycle / Manual Regeneration:** Should you ever need to initiate a manual regeneration due to unexpected higher water use, use the **Regenerate Now** button in the App.

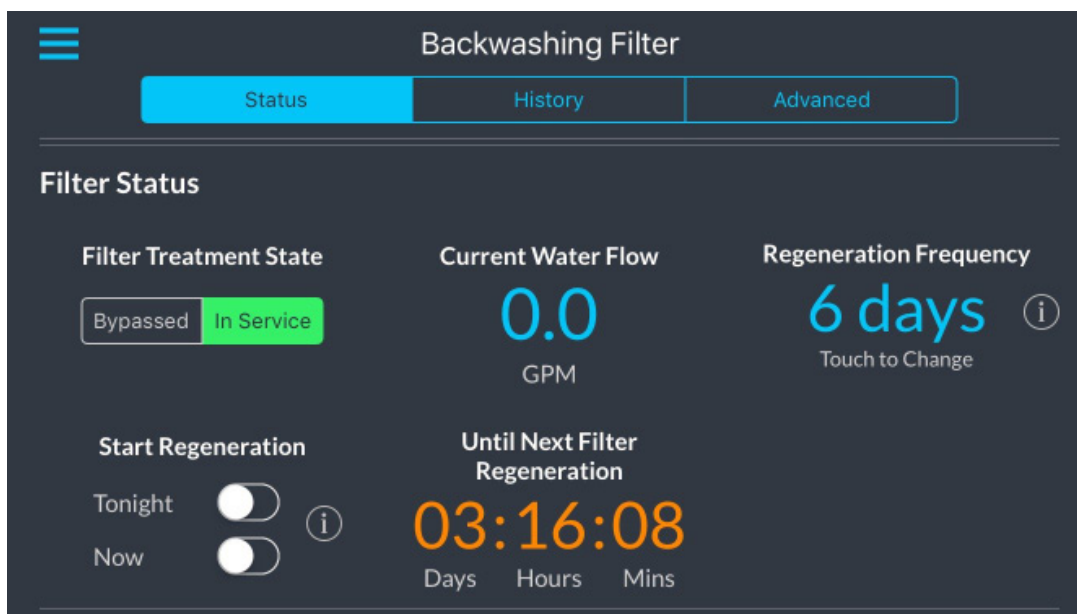

Devices > Filter > Status



*9 Volt Battery back up enables your valve to continue to protect your home from leaks during a power outage.*

# COMMON QUESTIONS

**There has been a drop in my home's water pressure. What can be the cause?** A reduction in your home's water pressure can indicate that it is time to change your prefilter (if one is being used) or that your filter needs to backwash more often. Try increasing your backwash frequency, and follow the steps above to initiate a regeneration. If you do not have a prefilter with your system and if backwashing the filter has no effect, contact your authorized DROP Water Management System representative.

**My water doesn't seem filtered. How can I be sure that my system is regenerating properly?** Be sure that the water supply to the filter is not bypassed. Follow the instructions in the "Extra Cycle / Manual Regeneration" above to manually backwash the filter. If the unit does not advance through to the next regeneration automatically, please contact your DROP Water Management System representative for further assistance.

**If at any time you feel your system is not operating properly, bypass the system and call your authorized DROP Water Management System representative.**



# HOW IT WORKS

The DROP system has been designed to be your home water management system. It treats your incoming water supply to give you quality water in your home. It monitors water usage and can help to alert you to excessive water usage and prevent or reduce water damage in the event of a burst pipe or a failed appliance. The DROP system can be tailored to your home's unique needs and your personal desires.

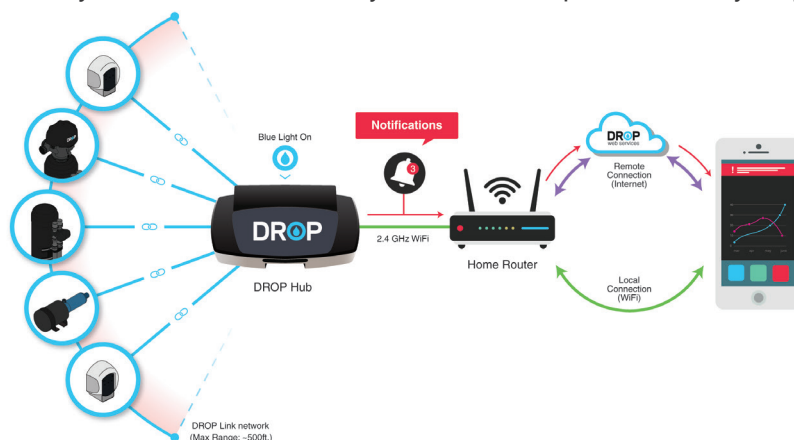

The DROP devices that are a part of your home water system are coordinated and controlled by the DROP Hub. The DROP system uses a proprietary wireless network called DROPLink that operates all the devices on a network. DROPLink is separate from and on a different frequency from your home WiFi. This gives the system resilience in that even if your WiFi or internet goes down, your DROP system will continue to operate, monitor and protect. It also keeps unnecessary traffic off your WiFi network.

The Hub is the only component that has a WiFi radio on it. You can connect to in 3 modes that give a user complete flexibility to set up their DROP system to best suit their needs and desires.

1. Direct connection: the DROP Hub creates its own secure WiFi network. Using the DROP app on a smart phone or tablet you can connect directly to the Hub and view status and change settings. This mode allows someone who may not have an internet connection to still be able to take advantage of many of the features of the DROP system. Hub 2 can also accept direct connections using Bluetooth if you are close to the hub.
2. Local WiFi connection: is very similar to direct connection mode, with the advantage of being able to connect to the DROP system without having to change the WiFi network on the smart phone or tablet being used to connect.
3. Cloud connected: using DROP Connect web services. This allows the DROP Hub to connect securely to DROP Connect servers. This enables notifications to be sent when there is an event that you need to know about and it allows you to monitor and control the DROP system from anywhere that you have an internet connection.

The DROP system makes it easy to add to your system as the needs of your home change and as the DROP product line continues to expand. Adding a new device to the DROP network is as easy as setting the Hub to look for new devices, and then power up the device you would like to add. Your new device will be connected to the system and your DROP Hub will already know how to integrate it into the system.

The DROP system user interface is implemented using the "DROP Connect" App. The App is available for Android and Apple smart phones and tablets. This gives you the convenience to have an intuitive user interface that is always with you. You no longer need to be standing in front of the equipment trying to figure out how to change the settings using a few buttons and cryptic text. The App includes many helpful hints and full descriptions of system settings and operation so you are not guessing as to what the information or settings are about.

# DOWNLOAD THE APP

Before you get started, there are few things you are going to need to do.



## Install your Water Appliance(s) First!

It is recommended that you plumb your water appliance(s) into your water system before powering your DROP system. Please see the documentation regarding the installation of your particular water appliance(s) that you are installing for specific installation instructions

## Download the DROP Mobile App

The DROP Mobile App can be found on both the Apple® Store and Google Play store. Just open the QR code or search for “DROP Connect” on Google play or at the App Store and look for the DROP icon .



Apple Store: <https://itunes.apple.com/us/app/drop-connect/id1269747593?mt=8>

Google Play: <https://play.google.com/store/apps/details?id=com.chandlersystemsinc.dropconnect>





# BEFORE YOU BEGIN

## Place your DROP Hub

The DROP system is a wireless operating system making placement of the Hub very flexible. However there are a few things to keep in mind when you locate the Hub. If you are planning to connect your Hub to your home WiFi be sure to place the Hub within range of that network. The range of the DROPLink network gives adequate coverage to a majority of homes without the use of repeaters. Any device on the DROP network that is powered from an outlet power source can act as a repeater. However, placing your DROP Hub in a central location in your home gives it the best chance of being able to reach all the devices on the network without the need for DROP repeaters.

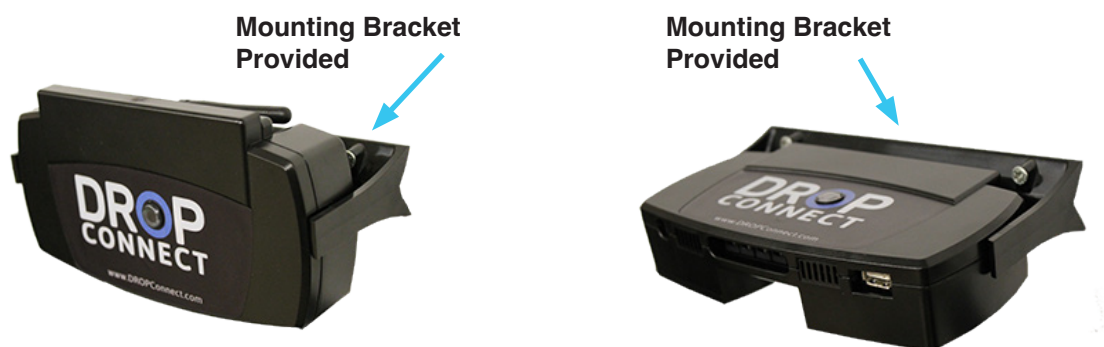

# BEFORE YOU BEGIN CHECKLIST

## Quick Checklist

Before you continue with installation, let's make sure the following steps have been completed.

You have:

- ✓ Installed or plumbed in your Water Appliance(s)
- ✓ Downloaded the DROP Mobile app on your smartphone
- ✓ Placed the DROP Hub in a central location and powered it up





# GUIDED SETUP FIRST ITEMS

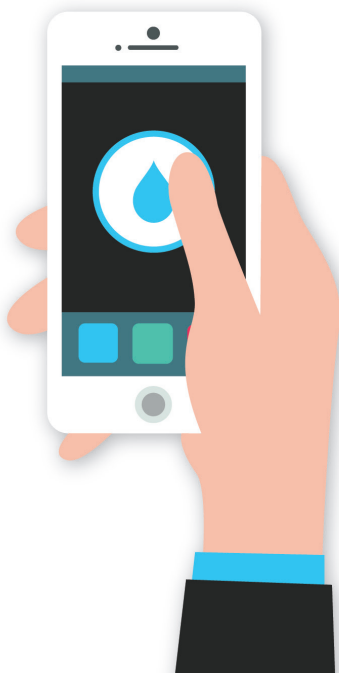

## Easy Configuration

Nearly all configurations and options are located in the DROP Mobile App! This section will walk you through the mobile setup to get you up and running!

## DROP App Setup

This guided setup process will connect your smartphone and DROP Connect App to your DROP system. If desired, it will also connect your DROP system to your WiFi network and create an account on DROP Web Services. This process is necessary to control your DROP system.

After first installing the app, you will see 4 options on the home screen. Chose the one applicable to you.

- If this is a new DROP system and you do not already have an account click **GUIDED SETUP**
- If you are trying to connect directly to a DROP system without connecting to WiFi click **CONNECT TO A DROP SYSTEM**
- To access your all ready setup DROP account and system click **LOG IN**
- To create an account so that another user can add you to an existing DROP system, click **CREATE NEW DROP ACCOUNT**

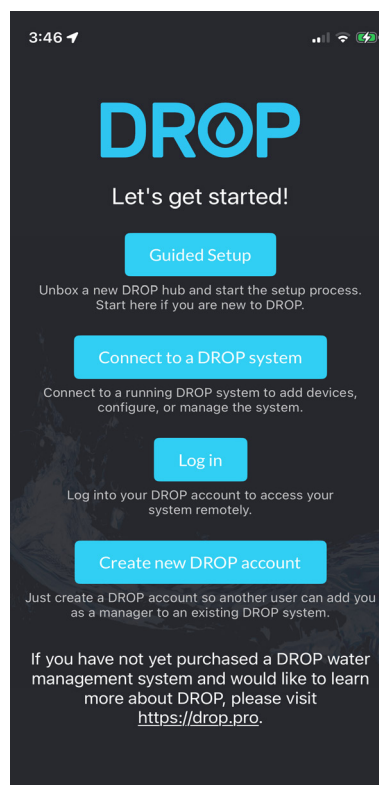

# GUIDED SETUP YOUR HOME SETUP



Click **ALLOW** on all permissions app requests for the app in order for your system and remote access to work properly

## Connect to a DROP System:

*Installer Setup Using Direct Connection*

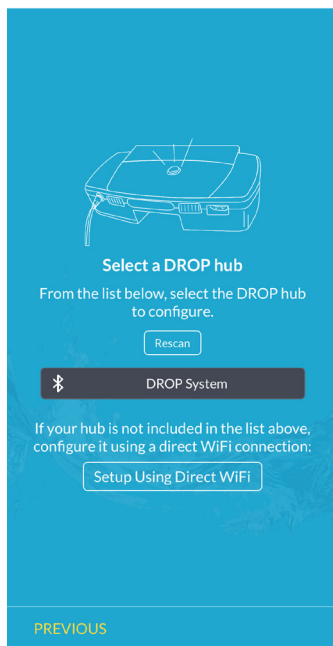

Select your DROP System to connect to the hub via Bluetooth

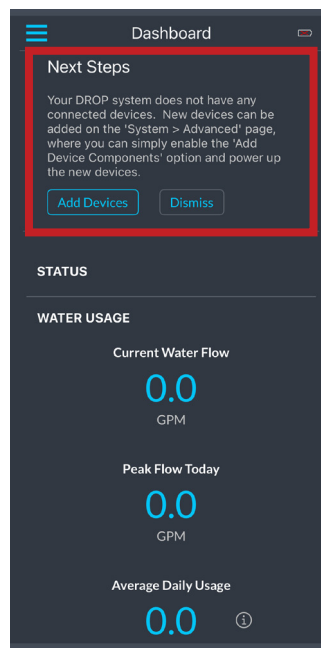

On the dashboard, under Next Steps, click Add Devices to begin syncing your DROP products to your DROP hub. For more information on adding devices, go to Adding and Naming Devices on page 11 & 12

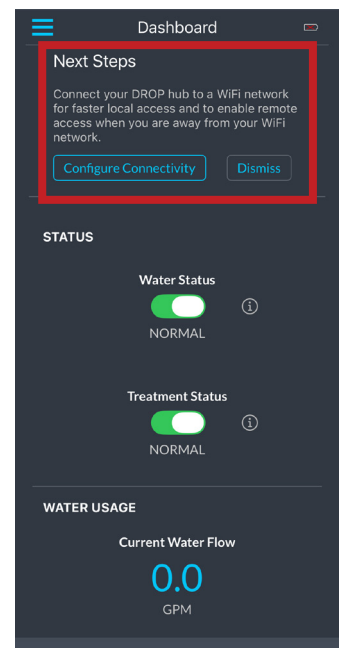

The Next Step is for the homeowner to connect WiFi. Have owner create an account and click configure connectivity to setup.



# GUIDED SETUP WITH EXISTING NETWORK

## Guided Setup: Homeowner Setup Using WiFi Connection

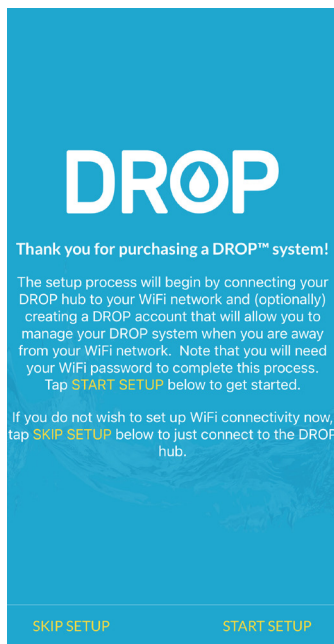

Click **START SETUP** if you are a homeowner connecting your DROP system to WiFi. If you are an installer click **SKIP SETUP** (See pg. 9)

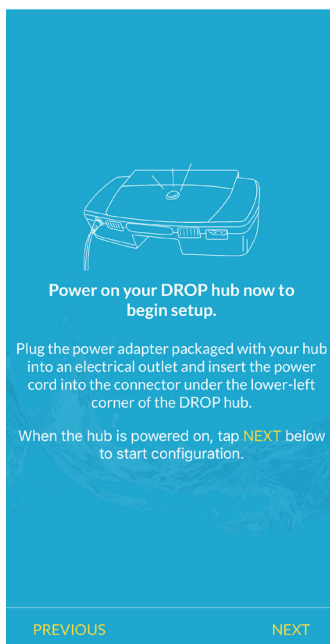

Plug in your DROP Hub, and click **NEXT**

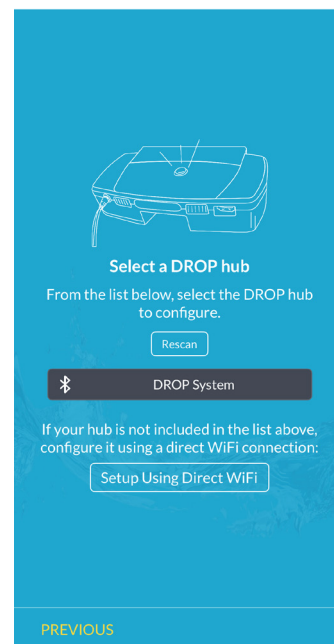

Select your DROP System to connect to the hub via Bluetooth

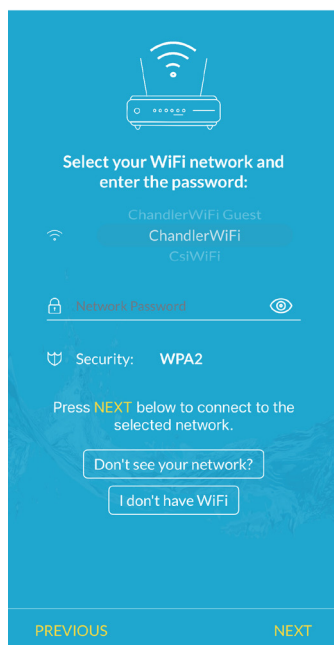

Select your WiFi network and enter network password to connect the DROP system to WiFi. Click **NEXT**

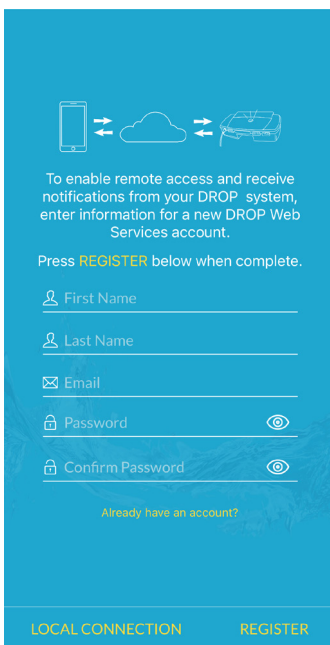

Create your DROP account to receive notifications about your DROP system. Click **FINISH**.

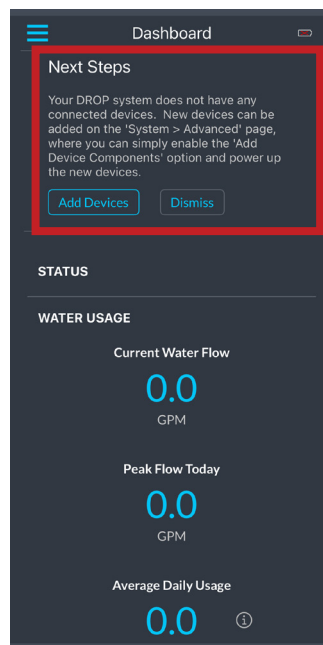

On your dashboard, under Next Steps, click add devices to begin syncing your DROP products to your DROP hub

# ADDING DEVICES



**NOTE:** You will need to go into your email and click confirm for your DROP account before accessing your dashboard.

## Adding Devices

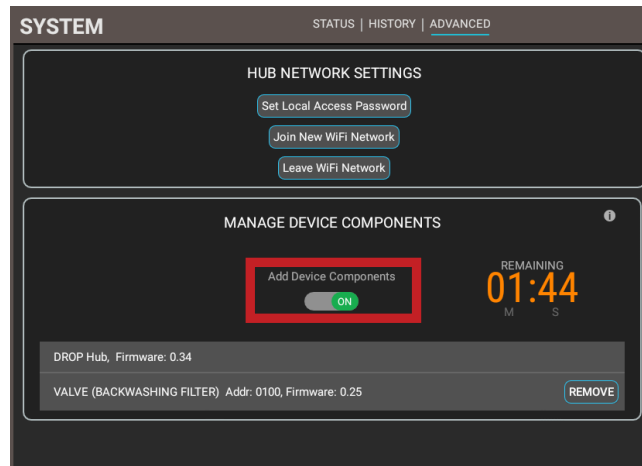
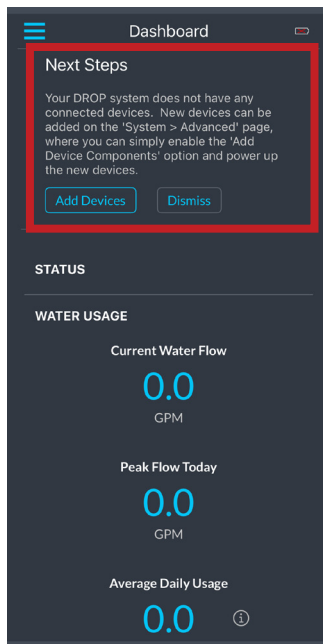

If no devices have been added to the Hub, the app will prompt you to “Add Devices Now”. This will take you directly to the SYSTEM > ADVANCED page in the app.

Unplug and remove any batteries from the DROP device you wish to add. Next, turn on the “Add Device Components” switch by tapping on it. Immediately power up your DROP device by plugging it in, or inserting batteries (for leak detectors). You can then disable the ‘Add Device Components’ mode or simply wait for it to automatically disable.



# NAMING DEVICES

## Naming Devices

The DROP system and DROP devices can all be named to make identification easier. This can be done in the SYSTEM > SETTINGS page of the app. Naming the DROP system is especially useful if you have more than one DROP system to manage, or if you have multiple of the same device. A good example of this is when you have multiple leak detectors; you can name one “Utility Room Leak Detector” and another “Upstairs Bathroom Leak Detector”. You will now be able to easily know which leak detector is reporting a leak.

## Adjust System Settings

On the SYSTEM > SETTINGS page, there are two settings that need checked. The “Regeneration Time” is the regeneration start time for the entire system. If a system has a filter and a softener, they will regenerate sequentially (if needed) starting at this time of day. The second setting is the “System Water Source” setting. This decides if regeneration is allowed to complete if the valves and hub have batteries installed, and the power fails while regeneration is taking place. If the water supply relies on an electric pump then this should be set to “Private Well”; if the water is city water, set to “municipal supply”. Note that these settings will be absent on DROP systems that do not have a backwashing filter or softener.

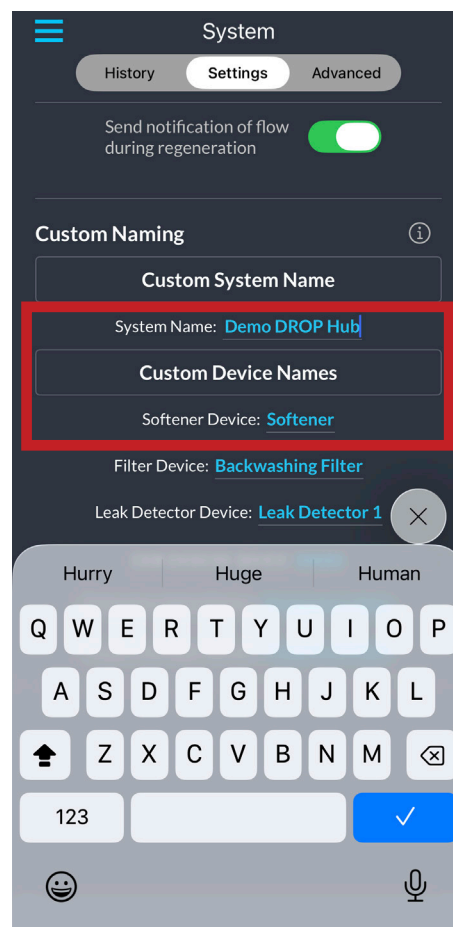

If you are not sure which leak detector is which, go to the DEVICES > LEAK DETECTORS page and press the Check/Silence button on one leak detector. A green check mark will appear next to the leak detector that just checked in.

# TROUBLESHOOTING WITH EXISTING NETWORK

## WiFi Router Configuration

If your App is having trouble making a local connection to your Hub there are a few things you can try to remedy the problem.

## Troubleshooting Steps

1. Please note that the DROP Hub requires a 2.4 GHz WiFi network to connect to. Also Hub 1, should not be connected to a “guest” type network that has device isolation security enabled. This will prevent the app from being able to communicate locally with the Hub. Hub 2 technically can be used while connected to a “guest” WiFi network, but local communication with the app will be limited to Bluetooth connections.
2. Confirm that your smart device is connected to your local WiFi network, the same network that the Hub is connected to.
3. When scanning for your DROP system on your network (see page 10) if you press the “Rescan” button repeatedly a dialog will pop up that gives you the option to “Scan Entire Network”. If you are on a home network choose “OK” and then press “Rescan” one more time after it becomes available. This type of scan should find the Hub if it is on your network. If you are on a corporate network you should contact your network administrator regarding your problems connecting to your DROP system.
4. You can try rebooting the Hub by pressing and holding the button on the front. The button will turn pink after a few seconds (2-4 seconds for Hub 1, and 4-6 seconds for Hub 2) Releasing the button while it is pink will reboot the Hub. The Hub may take 30 seconds or so before it will show up in a scan after rebooting your DROP system. You may want to try scanning multiple times.
5. You can try rebooting your WiFi router. Typically, the easiest way to do this is to unplug your WiFi router for 10 seconds and then plug it back in. Routers can take several minutes to restart. Once you have confirmed that your WiFi network is on again, you can try scanning for your DROP system in the DROP app.

## Customer Support

The DROP Connect website is full of helpful information. Visit our [Knowledgebase Resources](#) for more information, videos, and other help.

If troubleshooting hasn't solved your issue, Chandler System Customer Support is available to help! Please call: 888-363-9434 for our customer support team.



# ALEXA & HOME ASSISTANT



## Setup Complete!

You have completed the initial setup of your DROP Device. Your home water is now ready to be controlled anywhere!

The following pages contain more documentation and graphics for further understanding your system. Everything from automating your devices to configuring your notifications

## DROP works with Alexa

Connecting your DROP system to Amazon Alexa provides voice control for a few of the most commonly used DROP features. You can quickly check your daily water usage or turn your water back on after a weekend away by saying "Alexa, ask DROP Connect to check my water usage" or "Alexa, ask DROP Connect to turn my water on". To learn more about the available commands, say "Alexa, open DROP Connect."



How to connect Amazon Alexa to your DROP system

Simply enable the 'DROP Connect' skill in the Alexa app and follow the on-screen instructions to link Alexa to your DROP Web Services account

## DROP works with Home Assistant



Home Assistant is the premier open-source home automation platform that prioritizes local control and privacy. It's designed for the discerning homeowner who wants to automate their living space without reliance on an internet connection. By integrating with Home Assistant, DROP leverages a platform that supports a vast ecosystem of devices, allowing for sophisticated automation and monitoring capabilities. This collaboration aligns perfectly with our history of delivering cutting-edge technology that enhances your quality of life and our vision to revolutionize water systems.

# OPERATIONS MOBILE APP

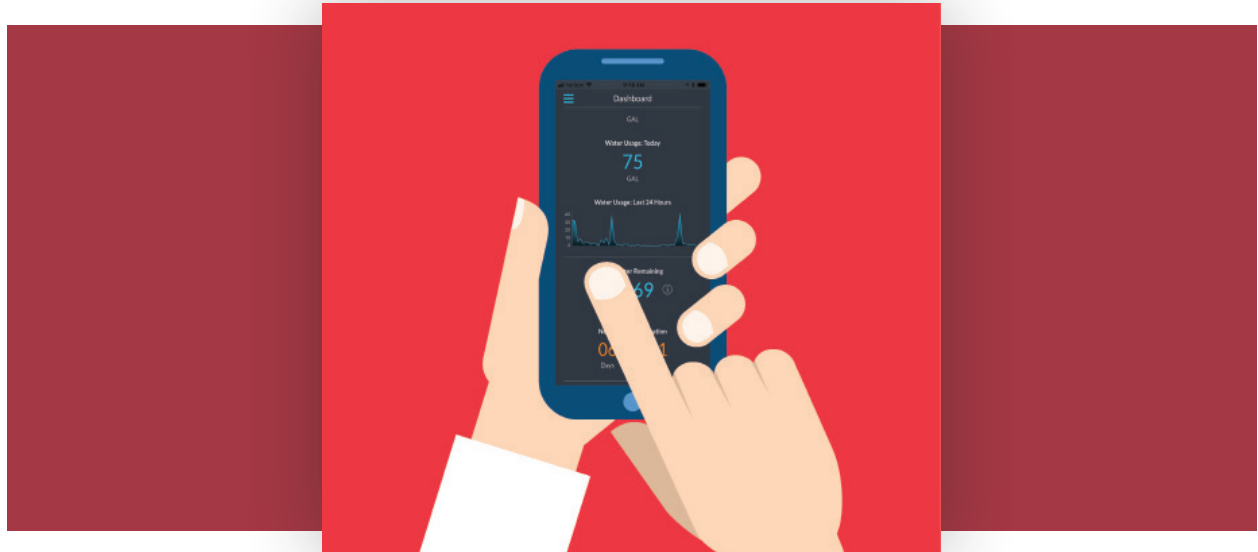

## Using the App

The DROP App has been designed to organize the many functions and settings of the DROP system in an intuitive manner. Almost all items in the App can be touched to change settings or to obtain more information. Any item or setting that could cause potential undesired operation will show a confirmation dialog box with more information when the setting is pressed. Also, information icons are available to give you more information about individual settings throughout the App.



*Common gestures are used in many areas of the DROP Connect app. The information icon is also helpful*

All graphs of data can be expanded to see more detailed information by touching the graph. Once the larger graph view is opened the detailed data can be viewed by pinch zooming and scrolling the graph area. Common smartphone gestures can be used here. Use your fingers to tap, zoom in, zoom out, and move to



# OPERATIONS CONNECTION TYPES

## Local Connection vs. Remote Connection

Your DROP App should prefer to connect to your Hub using a local connection rather than the remote connection through the DROP Connect web services. You can tell whether your App is connected in local or remote mode based on the color of your connection icon in the lower left of your Navigation menu in the App. If the icon is green, you are using a local connection. If the icon is blue, you are using a remote connection. Another type of connection is a local Bluetooth connection. If you are connected to your Hub 2 using Bluetooth, the connection icon will be a white Bluetooth logo.

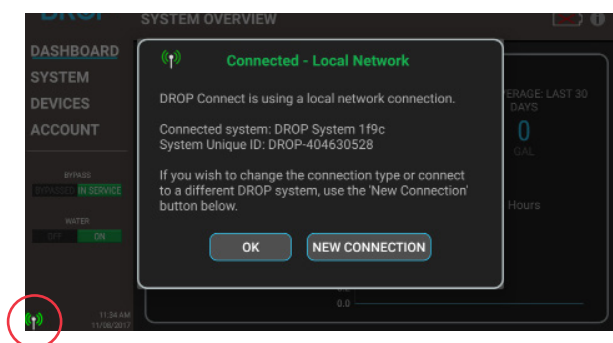
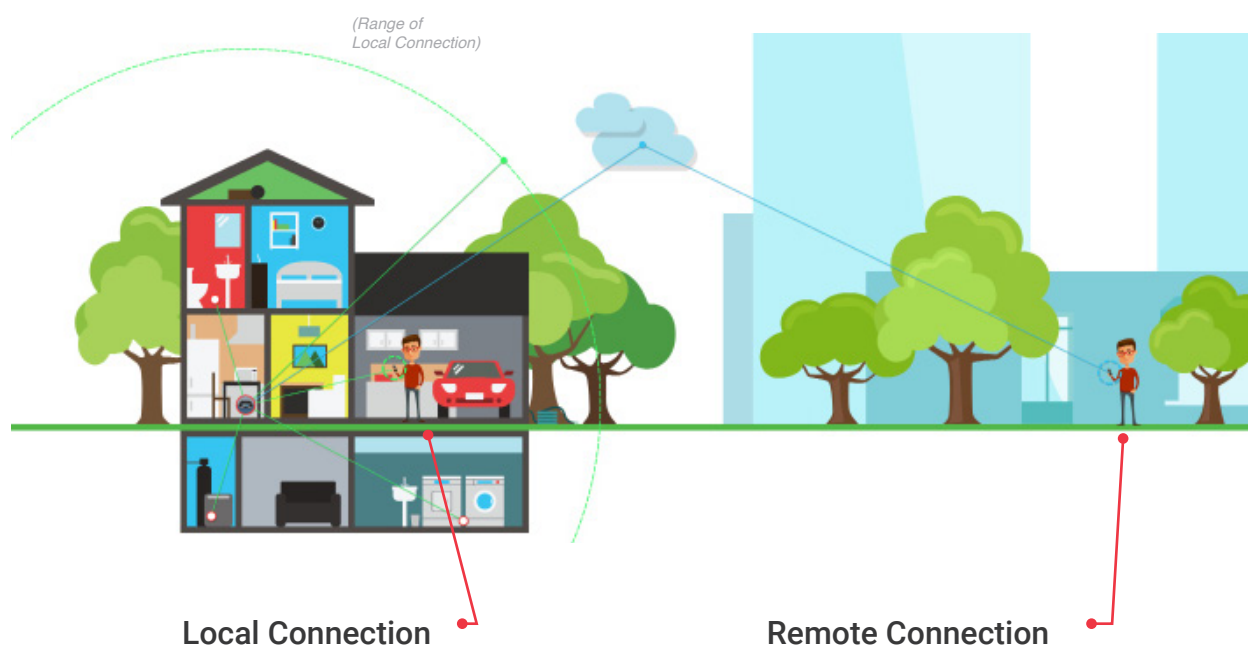

If you are within local range of your Hub, you will direct connect to the Hub. Shown with a Green symbol.

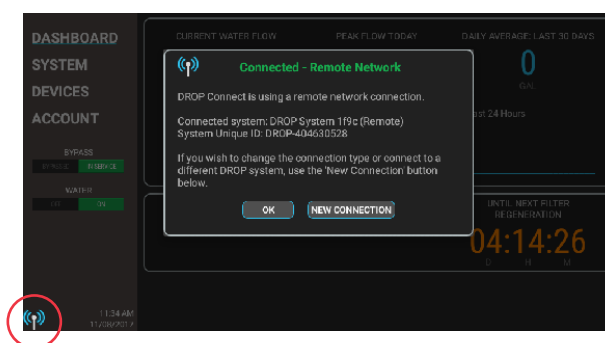

If you are connected to any mobile network or roaming network, you will connect via remote connection. Shown with a Blue symbol.

A local connection is preferred because it is faster, there are no limitations in functionality and a local connection is required to do firmware updates to the Hub and devices. If your App is connected to your Hub via a remote (blue icon) connection and you believe it should be able to connect locally, tap the connection icon and in the dialog box that pops up tap the “New Connection” button. This will cause the App to scan the network that the phone or tablet is connected to for any DROP systems that are connected. If your DROP system is connected to that same network it should show up on the list as a local connection.

### DROP Hub WiFi Status

Similar to the mobile setup process, DROP can operate in any network environment, with or without WiFi. The color of your DROP Hub light will indicate to you what connection mode it is in. Here is an overview of each mode. For Hub 1, the WiFi connection status is indicated by the light under the pushbutton. For Hub 2, refer to the 'WiFi Status' indicator light at the lower-right corner of the Hub.



#### Connected to WiFi and DROP Connect Services

The Hub has connected to a local WiFi network and to DROP Connect servers. The Hub is able to accept remote connections. In this mode there are two ways that the app can communicate to the Hub. If the phone or tablet is connected to the same local network as the Hub, the app can communicate directly over that local network.



#### Connected to WiFi only

The Hub has connected to a local WiFi network. To communicate to that Hub using the DROP app your phone or tablet will need to be connected to that same local network.



#### Direct Connection

The Hub is using its own private WiFi network (this is the default state on first power up). To communicate to that Hub using the app your phone or tablet will need to be connected to the DROP WiFi which will be named starting with "DROP\_System". Follow the instructions for one of the connection modes in the section "Connecting the app to the DROP system" to have the app walk you through making that connection.



#### Lost WiFi Signal

The Hub cannot connect to the WiFi network it was previously connected to. If this persists for more than a few minutes, check that the WiFi network is available using another device, and make sure the SSID or password of that WiFi network has not changed. If it has not changed and can be connected to using other devices, reboot the Hub. If it has changed, set the Hub to direct connection mode (see Adv. Hub Pushbutton Functions) and then connect it using the new credentials.



# OPERATIONS DROP HUB - PUSHBUTTON

## DROP Hub Water Status

On the Hub, the pushbutton light indicates the overall water status of the DROP system. When the water is turned on the pushbutton light will be green, and when the water is off the pushbutton light will be orange.

## DROP Hub DROPLink Status

The DROPLink indicator light at the lower-left corner of the Hub shows the status of the DROPLink mesh network at a glance. When all devices are connected and communicating normally, this light will be purple. Brief flashes indicate active communication with the devices. If a device is offline, this light will turn orange. When 'Add Device Components' mode is active, this light will turn white.

## Advanced Hub Pushbutton Functions

The pushbutton on the front of the Hub has been designed to perform some basic functions. By pressing and holding the pushbutton these functions can be accessed. As you hold the pushbutton, the button color will change for the different functions that are available. The following list explains the functions that are available:

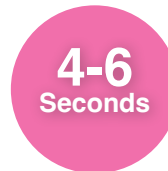

Releasing the button while it is green will turn the DROP system water on, while releasing the button while it is orange will turn the water off.

The button will turn pink. If released during this time frame the Hub will reboot. This can be helpful if you think something just isn't working right and you want to try a fresh startup to see if it fixes the problem. A reboot takes only a few seconds to complete and is generally not disruptive to any of the normal functions of the system.

# OPERATIONS DROP HUB - PUSHBUTTON



Seconds (yellow or blue): If the DROP Hub is connected to a local (blue or green before pressing the button) WiFi network, button color will be yellow. If released during this time frame the Hub will reset and temporarily revert to direct connection WiFi mode. Once in direct connection (WiFi Status blinking yellow with button not pressed) WiFi mode, if button is held again for 7-9 seconds the button color will be blue. If released in this mode the Hub will reconnect to the previous WiFi connection. Switching to direct connection WiFi mode can be helpful if you want to temporarily allow someone to access your Hub, but don't want to give them access to your local WiFi. This also can be helpful if your WiFi router is no longer available and you need to connect to your DROP system. Finally, it is a way that can be used to connect a Hub to a new WiFi without resetting the Hub.

The button will turn green. If released during this time frame the Hub will reset the app pairing key. This will cause all apps that only have local access to the Hub to be required to be repaired when they attempt to connect next. When the pairing key is reset, a notification will be sent out that the app pairing key has been reset. The local pairing key ensures that a user must have direct physical access to the Hub in order to connect and also ensures that the appropriate users are notified of the app pairing key change. Note: If a user has remote access to this DROP system, through DROP web services, they will not be required to repair their app to the Hub. To control who can remotely access the DROP system go to the "ACCOUNT" page in the app.



## Factory Reset

A factory reset will clear all data from the hub and remove any connected devices. Typically, a factory reset is only necessary if suggested by DROP technical support staff. If a hub currently has remote access enabled it is recommended that remote access is disabled before a reset, especially if the hub will be used by someone else. Otherwise, the hub will remain locked to the original account and cannot be used by another account. To disable remote access, go to the Account page in the app and look for the 'Disable Remote Access' button.

To perform a factory reset, first remove the backup battery from the hub. Unplug the hub, depress the pushbutton, and plug in the hub while continuing to depress the pushbutton. After 30 seconds, the button will turn orange. Release the pushbutton while it is orange, and the hub will be armed for a factory reset while the button is red. If the button is pressed again while the button is red, a factory reset will be performed. If the button is not pressed again within 10 seconds, the factory reset will be canceled, and the hub will start normally.

# OPERATIONS FIRMWARE UPDATES

## How to Update Firmware

The DROP Hub and all DROP devices have firmware that is programmed on each DROP component and controls how the DROP system operates. The DROP system is designed to be able to update the firmware in order to add new features and fix or improve operation. New firmware updates are distributed in the DROP App and can be downloaded to the DROP system using the app. The app will prompt you that new firmware is available when you open your app and connect to your Hub in local mode. Choosing “Install Updates Now” will take you direct to the System > Advanced Page.

 System > Advanced

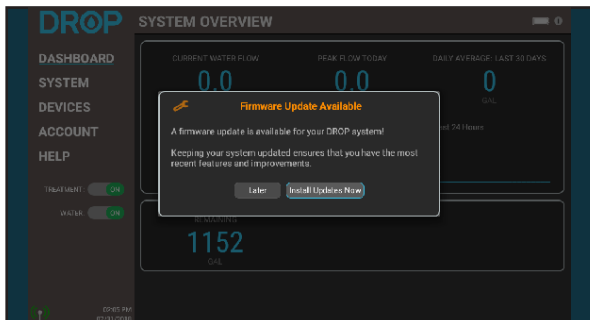

Firmware Updates Pending

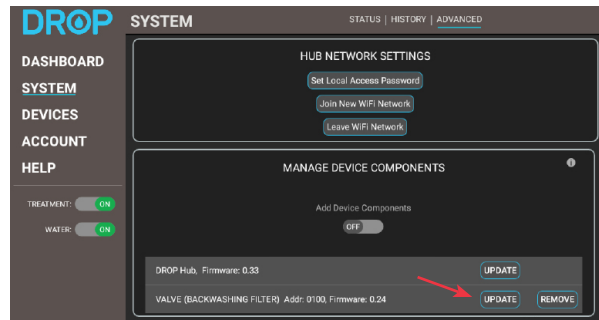

Firmware Updates Pending

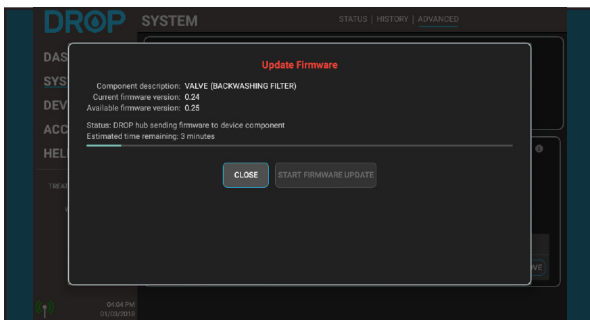

Sending Hub Firmware Update

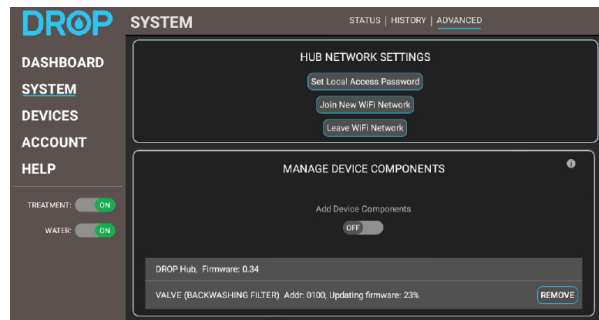

Firmware will continue to be transferred. Once complete, the update has been initiated

Any devices that have an update available will have an “Update” button next to them. An available Hub update must be installed before device components can be updated.



**NOTE:** The App needs to remain open while the firmware data is being sent to the DROP Hub.



# OPERATIONS DROP VALVE - LIGHTS - NORMAL

## DROP Lights - Normal Operation

Your softener and/or filter will normally be in the service position. This is its normal position that treats the incoming water supply. The different treatment valve types have different colors when they are in their service position, so they can easily be identified by the color of their lights. These colors are identified in the list below:



Softener - Green



Filter Valve (Backwashing or  
Aeration Filter) – Blue



Cartridge Filter – Cyan

While observing your device, you will notice periodic purple flashes on the back lights. These indicate that it is wirelessly communicating to the Hub during that time. Also, when the water meter on your unit senses water flow, the front lights on your device will alternate. The rate of alternation of the lights will give a general idea of the current flow rate. The highest frequency of the lights alternating is determined based on the highest flow seen by your system.

The lights will change color when your device or devices are put into Bypass mode or Water Off. If your water is off, the lights on the valves will be orange. The water can be turned back on using the app or by shortly pressing the button on the Hub. If one of your valves is bypassed, its lights will be bright yellow. Bypassed means that water will not be treated by that device while it is in bypass mode. This may be helpful if you wish to not use treated water in a particular situation, such as watering the lawn.

## DROP Lights - During Regeneration

When a treatment valve is in regeneration the lights will change color for each step in the regeneration process. While the valve is sitting in a step of the regeneration process the lights will be slowly fading from side to side (wobble). If the valve is moving to a position the lights will rotate according to the direction of the motor movement to get to that position. The colors for each position are as follows:



Aeration Filter

Position	Color
Decompress	Pink
Air Release	Lime
Backwash	Purple
Rest	Light Yellow
Air/Chlorine Draw	Light Pink
Rapid Rinse	Light Blue



# OPERATIONS LEAK DETECTORS



DRoP Leak Detector Device.

## Leak Detector Overview

The DRoP leak detector is designed to detect water leaks and temperature conditions that can cause water leaks. It is powered by 2 AA batteries, which under normal circumstances will last for several years of operation. A leak detector monitors its leak probe input for water.

If water should come in contact with the probes, the leak detector will immediately report the leak to the DRoP system. The DRoP system will immediately send a notification of the leak (if connected to DRoP web services) and will shut the water off at the DRoP valves. Shutting the water off can optionally be turned off if your leak detector is not monitoring a system component that is affected by normal source water (such as a condensate pump). The leak detector that sensed the leak will then chirp every 16 seconds and the yellow leak light will flash every 2 seconds.

## Leak Detector Placement

In order to reliably detect a water leak, it is very important that the location where the leak detector is placed is well thought out. First, when considering where to place leak detectors think about the locations in your home that use water. Next, think about what locations are most vulnerable to problems. For example; appliances that use water and run unattended, pipes that are more susceptible to freezing, or toilets that are known to overflow or leak.

Also, think about the consequences of water in those areas. Maybe monitoring a water heater in an unfinished basement isn't as important as monitoring a bathroom on the second floor of a home. Prioritize the locations that need protected the most. Also, keep in mind that if more leak detectors are needed, you can add up to 52 leak detectors to your DRoP system at any time. Finally when you place the leak detector we recommend that you test where water will tend to accumulate by purposely spilling a small amount of water in that area. Once you observe where water naturally moves to, you should accordingly place your leak detector in that location. Don't forget that you can name your leak detectors according to their location in the app, on the SYSTEM > STATUS page. This will help you locate a problem quickly if a leak does occur. Leak detectors can obviously be placed in the location that you want to detect leaks.

However, there are available accessories for leak detectors to allow more flexibility in their placement and use. A wall mount bracket and a leak detection extension cable are available and can be used to securely mount your leak detector and permanently mount the leak probes exactly where they need to be located.

# OPERATIONS LEAK DETECTORS CONT.



*DROP Leak Detector Extension Cable and Extension Cable being used.*

## Leak Detector Operations

Once you have placed the leak detector in the location that you would like, press the “Check/Silence” button. After a few moments, the green okay check mark should light up indicating that it was able to communicate with the Hub. If the red no network light turns on instead, then the leak detector is too far from a powered DROP component on the DROP device network. Any DROP device that is powered with a wall plug power supply can repeat the messages to the Hub.

The options for helping a leak detector connect to the Hub are:

1. Move the DROP Hub to a more central location in your home.
2. Move another DROP powered component closer to the leak detector you are trying to connect to.
3. Add a DROP Remote to your network in-between the Hub and the leak detector that you are trying to

## Leak Detector Settings

Leak detectors are ready to use as soon as they are connected as a device to your DROP system. If you have not yet connected your Leak Detectors to the system, please see the section “How to Add Your Devices” on page 14. Once connected, by default they will shut off the water when a leak is detected and send a notification.

By going to the Devices menu on the left side of your app and then choosing Leak Detectors, you can decide for each leak detector if it should shut off the water, or just send a notification. Leak detectors also monitor temperature. High and low temperature set points can be set for each leak detector. If the temperature should surpass the set point a notification will be sent.

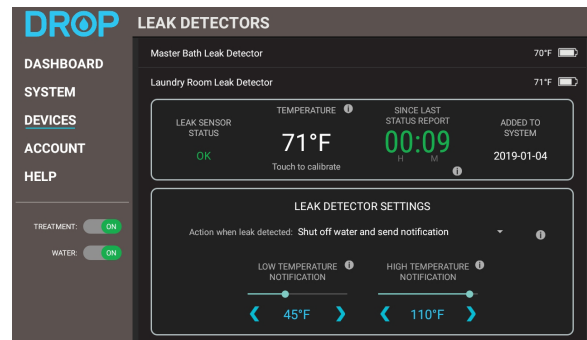

*Leak Detector Status screen.*



# OPERATIONS LEAK DETECTORS CONT.



## Reporting Operation

Leak detectors report to the Hub every 10 minutes under normal circumstances. If the leak detector does not succeed in checking in, it will try again repeatedly until it succeeds. When the leak detector has missed a check in, it will flash its network light until it is able to connect to the Hub again. If it has not succeeded in checking in with the Hub after one hour, the Hub will send a notification that the leak detector has lost connection. If this happens regularly, you may need to help improve the DROP network as indicated at the end of the section Leak Detector Operations.

If a leak occurs, temperature changes significantly, or temperature surpasses a set point, the leak detector will report to the Hub immediately.

## Battery Operation

Leak detectors use 2 AA batteries to operate. The detectors typically sleep most of the time and therefore use very little power. Under normal operating conditions, they will operate for several years on the same set of batteries. When they do get low the low battery light on the leak detector will begin to flash and the leak detector will chirp once a minute (but only outside “Quiet Time” hours). A low battery notification will also

## Leak Detector Factory Reset

It is recommended that before performing a factory reset, that you remove the leak detector as a device on any DROP system that it might be attached to. This can be done while using a local connection in the App and going to SYSTEM > ADVANCED page. On that page, you will see “Manage Device Components” Find the leak detector in that list and press the “Remove” button associated with that unit. Once it is removed then perform the factory reset.



### SYSTEM > ADVANCED : MANAGE DEVICE COMPONENTS

To reset a leak detector and cause it to forget any DROP network that it has been connected to, press and hold the button while inserting the batteries. Continue to hold the button for 15 seconds. During this time all the lights will be on solid. Once the button has been held for 15 seconds, the lights will begin flashing once per second. At this point the leak detector is armed for reset, release the button and then press it again to cause the leak detector to be reset.



## DROP Remote Overview

The DROP Remote shows the status of your DROP system at a glance and allows you to conveniently turn your water supply on or off. The Remote also extends the range of the DROP Link mesh network.

If you have not yet connected your Remote to the system, please see the section “How to Add Your Devices” on page 14.

## DROP Remote Placement

If the remote is going to be primarily used as a user interface, it should be hung on a wall or placed on a counter top so it is convenient to see and to control your home water state. However, if you need to extend the range of the DROPLink network you can place the remote at a location between the Hub and the devices you need to extend to. The DROP Remote is a network extender that will improve communications between the DROP Hub and distant DROP devices. The construction of every home is different, and you may need to experiment with the location of the Remote to find the optimal placement.

Up to 8 DROP remotes can be connected to a DROP Hub as user interfaces and/or network extenders.

### Lights

The lights on the DROP Remote indicate if the DROP system is in service or shutoff. While the system is in service, the lights on the Remote will be green. When the system is in shutoff, the lights will change to orange. You can control the behavior of the lights on the Remote in the DROP Connect App.

If there is a DROP notification that has not been seen in the app, the Remote will slowly blink a blue light. As with other DROP devices, periodic purple flashes indicate that the Remote is communicating with the DROP Hub and other DROP devices.



**NOTE:** *The notifications or network activity indication must be enabled in the App to be visible on the Remote.*

### Pushbutton Functions

The DROP Remote has a recessed, touch sensitive button that can perform some basic functions. These functions can be accessed by pressing and holding the button. As you hold the pushbutton, the light closest to the button will turn white to confirm the button press, and the top lights will change for the different functions available. The following list explains the functions that are available:



# OPERATIONS DROP REMOTE



The remote lights will turn orange or green, depending on the remote's current position. If the remote is in service (green lights before the button was pressed), releasing the button while the lights are orange will send the valve to the shutoff position. Likewise, if the remote is in shutoff (orange lights before the button was pressed), releasing the button while the lights are green will send the valve to the service position.



The Remote lights will turn orange. If released during this time frame the remote will be armed for a factory reset and the lights will turn red. If the button is pressed again, once it is red, a factory reset will be performed on the Remote. It is recommended that before performing a factory reset, that you remove the Remote as a device on any DROP system that it might be attached to. This can be done while using a local connection in the App and going to System on the navigation menu on the left, and then the Advanced page (selected at the top). On that page you will see "Manage Device Components". Find the Remote in that list and press the "Remove" button associated with that Remote. Once the Remote is removed then perform the factory reset.



**NOTE:** *The intensity of the LED lights can be changed in the app.*

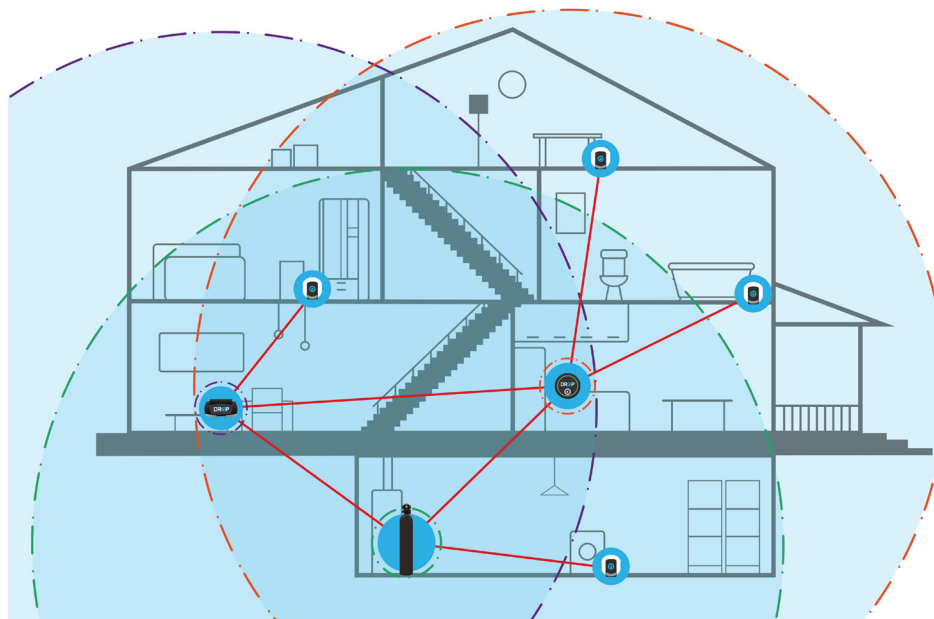

As shown above, all DROP devices that plug into 120 volt outlets expand the DROPLink mesh network. When placing the DROP Hub and Remote, keep in mind that installing them in separate areas of the home will expand the network. This is important to consider if you have leak detectors that are located in far extremes of the home. Up to 8 DROP Remotes can be added to a DROP system.



**If you wish to connect your system to local WiFi for remote control and notifications, please install the DROP Hub in a location that has a good WiFi signal.**

**Note: This equipment has been tested and found to comply with the limits for a Class B digital device, pursuant to part 15 of the FCC Rules. These limits are designed to provide reasonable protection against harmful interference in a residential installation. This equipment generates, uses and can radiate radio frequency energy and, if not installed and used in accordance with the instructions, may cause harmful interference to radio communications. However, there is no guarantee that interference will not occur in a particular installation. If this equipment does cause harmful interference to radio or television reception, which can be determined by turning the equipment off and on, the user is encouraged to try to correct the interference by one or more of the following measures:**

- Reorient or relocate the receiving antenna.**
- Increase the separation between the equipment and receiver.**
- Connect the equipment into an outlet on a circuit different from that to which the receiver is connected.**
- Consult the dealer or an experienced radio/TV technician for help.**

**This product may be covered by one or more patents. (<https://dropconnect.com/patents>)**

**Chandler Systems Inc.**  
710 Orange St.  
Ashland, OH 44805

P. 1 833 BUY-DROP  
[www.dropconnect.com](http://www.dropconnect.com)



## WATER MANAGEMENT SYSTEMS

This warranty cannot be transferred - it is extended only to the original purchaser or first user of the product. By accepting and keeping this product, you agree to all of the warranty terms and limitations of liability described below.

**Important Warning:** Read carefully the DROP Water Management Systems Equipment Installation, Operating and Maintenance Instructions Manual to avoid serious personal injury and property HAZARDS and to ensure safe and proper care of this product.

\*FOR AS LONG AS YOU OWN AND LIVE IN YOUR SINGLE FAMILY HOME, this warranty covers your water treatment equipment, if you are the first user of this DROP Water Treatment Systems equipment and purchased it for single family home use - subject to all of the conditions, limitations and exclusions listed below. Purchasers who buy the DROP equipment for other purposes, and other component parts are subject to more limited warranties and you should read all of the terms included in this form to make sure you understand your warranty.

What is covered by this warranty?

Chandler Systems, Inc. warrants that at the time of manufacture, the DROP equipment shall be free from defects in material and workmanship as follows:

Product	Warranty
Residential Mineral Tank	10 Years
DROP Control Valves	5 Years
DROP Pump Controllers	5 Years
DROP Home Protection Valve	5 Years
Brine Tank	5 Years
DROP Hub and Remote	1 Year
DROP Wireless Low Salt Alarm	1 Year
Other Accessories and Parts	1 Year
Brine Tank Components	1 Year

\* This warranty does not include media and/or cartridge filter elements.

### Additional Terms & Conditions

What Chandler Systems Inc will do if you have a covered warranty claim; Chandler Systems Inc will at its discretion either make repairs to correct any defect in material or workmanship or supply and ship either new or used replacement parts or products. Chandler Systems, Inc. will not accept any claims for labor or other costs.

### Additional Exclusions and Limitations

This warranty is non-transferable and does not cover any failure or problem unless it was caused solely by a defect in material or workmanship. In addition, this warranty shall not apply:

- If the equipment is not correctly installed, operated, repaired and maintained as described in the Installation, Operating & Maintenance Instructions Manual provided with the product.
- Defects caused as a direct result of the incoming water quality
- If the DROP equipment is not sized appropriately for the intended job.

- To any failure or malfunction resulting from abuse (including freezing), improper or negligent; handling, shipping (by anyone other than DROP)
- If the unit has not always been operated within the factory recommended temperature limits, and at a water pressure not exceeding 125 psi, during storage, use, operation, accident; or alteration, lightning, flooding or other environmental conditions.
- To any failure or malfunction resulting from failure to operate the system with potable water, free to circulate at all times; and free of damaging water sediment or scale.
- This warranty does not cover labor costs, shipping charges, service charges, delivery expenses, property damage, administrative fees or any costs incurred by the purchaser in removing or reinstalling the water management equipment.
- The warranty does not cover any claims submitted more than 30 days after expiration of the applicable warranty, and does not apply unless prompt notice of any claim is given to an authorized DROP Dealer or to DROP or a designated contractor is provided access to the installation and to the water treatment equipment.

THESE WARRANTIES ARE GIVEN IN LIEU OF ALL OTHER EXPRESS WARRANTIES. NO DROP REPRESENTATIVE OR ANY OTHER PARTY IS AUTHORIZED TO MAKE ANY WARRANTY OTHER THAN THOSE EXPRESSLY CONTAINED IN THIS WARRANTY AGREEMENT.

### Additional Warranty Limitations

ANY IMPLIED WARRANTIES THE PURCHASER MAY HAVE, INCLUDING THE IMPLIED WARRANTIES OF MERCHANTABILITY AND FITNESS FOR A PARTICULAR PURPOSE, SHALL NOT EXTEND BEYOND THE APPLICABLE TIME PERIODS SPECIFIED ABOVE. Some states do not allow limitations on how long an implied warranty lasts, so the above limitations may not apply to you.

### Limitations of Remedies

The remedies contained in this warranty are the purchaser's exclusive remedies. In no circumstances will Chandler Systems, Inc. or the seller of the product be liable for more than, and purchaser-user's remedies shall not exceed, the price paid for the product. In no case shall Chandler Systems, Inc. or seller be liable for any special, incidental, contingent or consequential damages. Special, incidental, contingent and consequential damages for which Chandler Systems, Inc. is not liable include, but are not limited to, inconvenience, loss or damage to property, consequential mold damage, loss of profits, loss of savings or revenue, loss of use of the products or any associated equipment, facilities, buildings or services, downtime, and the claims of third parties including customers. Some states do not allow the exclusion or the limitation of incidental or consequential damages, so the above limitations or exclusion may not apply to you.

### What to do if you have a problem covered by this warranty

Any warranty coverage must be authorized by Chandler Systems, Inc.. Contact the person from whom you purchased the product, who must receive authorization from a DROP Dealer.

If your product is new and not used and you wish to return it, contact your DROP Dealer.

